













TELEPÍTÉSI ÚTMUTATÓ

| | Név | db |
|----|---------------------------|--------|
| A | HOMLOK - FEJLÉC | 1 KS |
| B | ELŐLAP | 1 KS |
| C | OLDALFAL | 2 KS |
| D | KÖZÉPSŐ OLDAL | 1 KS |
| E | TÁMASZTÓLÁB | 3 KS |
| F | LÁBAK | 6 KS |
| G | ROST | 2 SADA |
| H1 | RETESZ-EGÉSZ | 1 KS |
| H2 | ALJZAT – ELSŐ (KICSI) | 2 KS |
| I | ALJZAT - ELSŐ RÉSZ | 3 KS |
| J | FIÓK – OLDAL (BAL / JOBB) | 3 SADA |
| K | ALJZAT - HÁTSÓ RÉSZ | 3 KS |
| L | FIÓK – ALSÓ | 3 KS |
| M | FIÓK - MEGERŐSÍTŐRÚD | 9 KS |
| N | KERÉK | 14 KS |
| O | Fejléc – LÁB (BAL / JOBB) | 1 SADA |
| P | OLDALTÁMASZTÓ LÁB | 4 KS |

| | Név | db |
|----|--|-------|
| 1 | CSAVAR JCBC M6 x 30  | 11 KS |
| | CSAVAR JCBC M6 x 45  | 3 KS |
| | CSAVAR M3,5 x 25  | 12 KS |
| 4 | CSAVAR M4 x 30 M3.5 x 38  | 12 KS |
| 5 | CSAVAR M4 x 30  | 18 KS |
| 6 | CSAVAR M4 x 45  | 44 KS |
| 7 | IMBUSZKULCS M4  | 1 KS |
| 8 | IMBUSZKULCS M5  | 1 KS |
| 9 | ALÁTÉT M6  | 3 KS |
| 10 | CSAVAR M3.5 x 16  | 28 KS |
| 11 | JCBB CSAVAR M8 x 30MM  | 6 KS |
| 12 | LAPOS ALÁTÉT  | 3 KS |

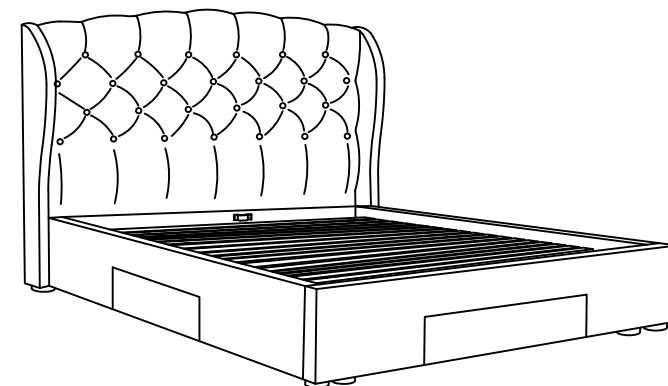

FIGYELEM! HA MOZGATNI SZERETNÉ AZ ÁGYAT, EMELJE FEL AZ ÁGYAT EGY MÁSIK SZEMÉLY SEGÍTSÉGÉVEL!

TELEPÍTÉSI ÚTMUTATÓ

4 LÉPÉS

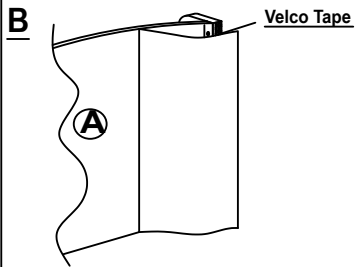
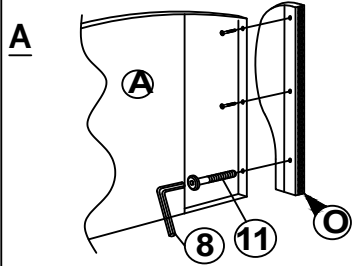

2 LÉPÉS

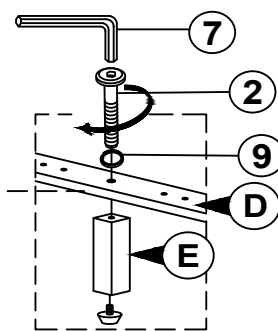
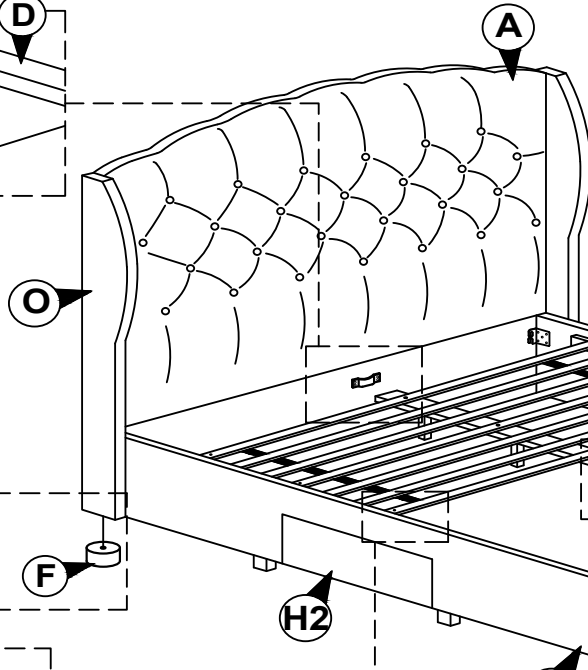
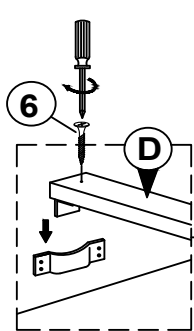

1 LÉPÉS

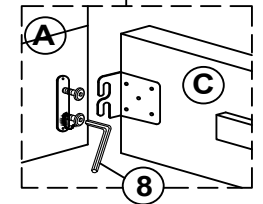
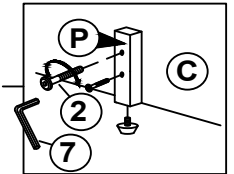
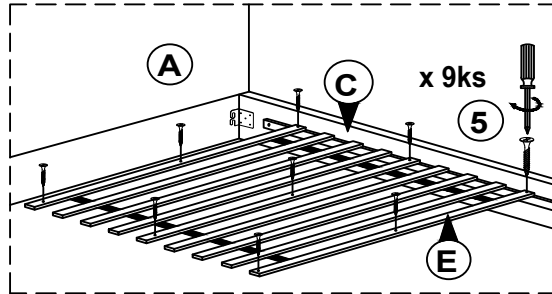
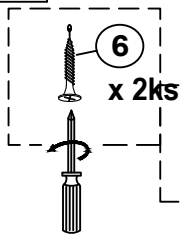
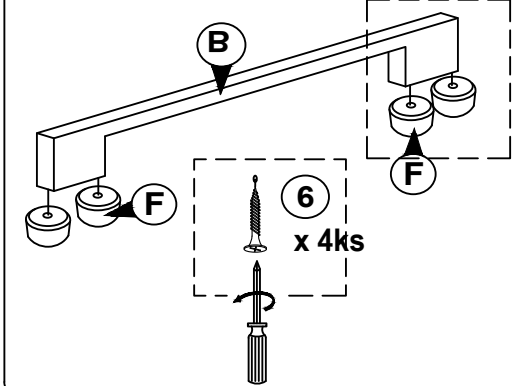

3.1 LÉPÉS

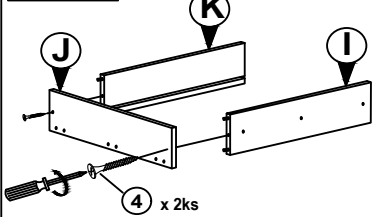

3.2 LÉPÉS

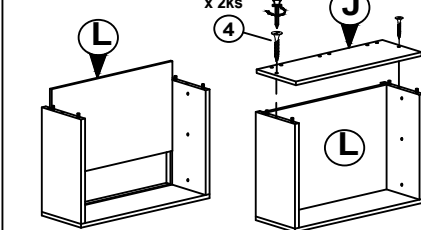

3.3 LÉPÉS

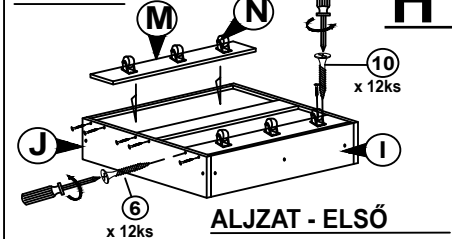

H1

H2

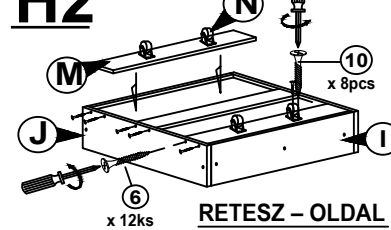

3.4 LÉPÉS

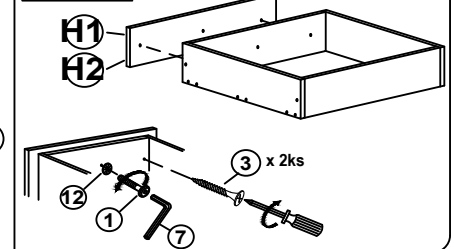

ALJZAT - ELSŐ

RETESZ - OLDAL